

WATER FALL Cascade spout for wall mounting - Champagne (22kt Gold)











IMO

13 420 979



- 120mm projection
- CASCADE, max. flow rate 26.5 l/min (at 3 bar)
- cover plate 240 x 60 mm
- 1/2" connection
- plug-link mounting

Fits: IMO, LULU, MADISON, MEM, TARA, CL.1, LISSÉ, VAIA, META, CYO

| | | |
|---|--------------------------------|---------------|
|  | Champagne (22kt Gold) | 13 420 979-47 |
|  | Chrome | 13 420 979-00 |
|  | Brushed Platinum | 13 420 979-06 |
|  | Platinum | 13 420 979-08 |
|  | Dark Chrome | 13 420 979-19 |
|  | Light Gold | 13 420 979-26 |
|  | Brushed Light Gold | 13 420 979-27 |
|  | Brushed Durabronze (23kt Gold) | 13 420 979-28 |
|  | Matte Black | 13 420 979-33 |
|  | Brushed Bronze | 13 420 979-42 |
|  | Brushed Champagne (22kt Gold) | 13 420 979-46 |
|  | Brushed Chrome | 13 420 979-93 |

Recommended miscellaneous



- Concealed wall elbow -**
- max. recess depth 163 mm
 - min. recess depth 90 mm

35 085 970 90

Recommended miscellaneous



- Concealed wall elbow -**
- max. recess depth 163 mm
 - min. recess depth 90 mm

35 085 970 90

13 420 979

mm [inches]



Flow rate chart



Trajectory diagram

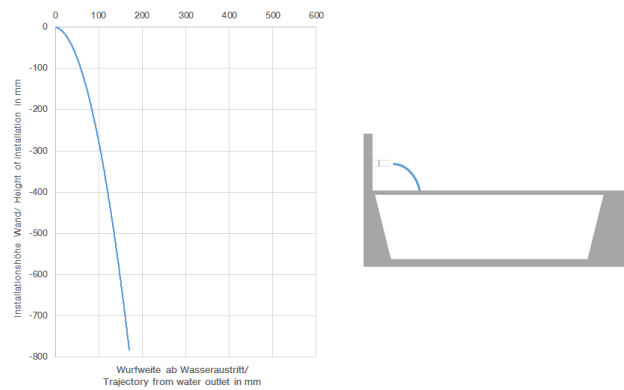

Certificates

LGA_18615.

13 420 979

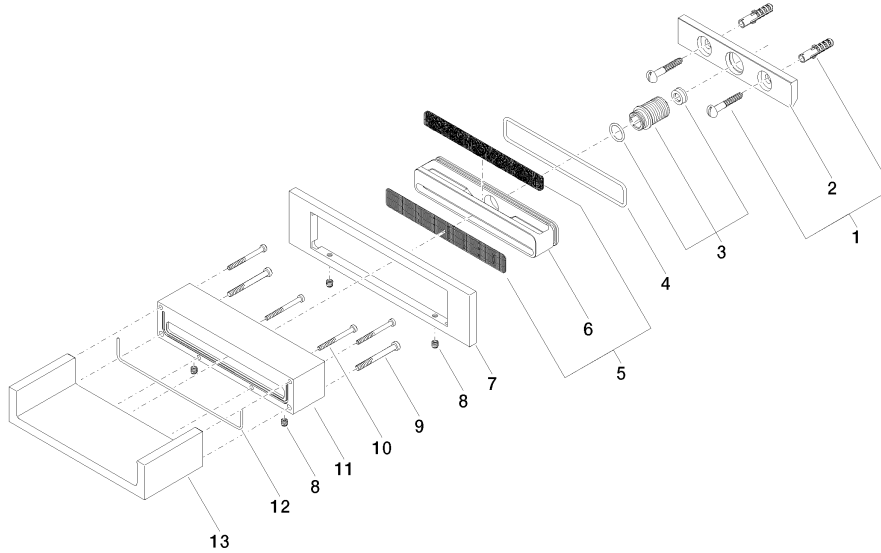

Spare parts list

| No. | Item Number | Name | Quantity used | Delivery time |
|-----|--------------------|-------------|---------------|---------------|
| 1 | 04 30 31 024 01 90 | fixing set | 1 | 2 |
| 2 | 09 17 97 056 90 | holder | 1 | 2 |
| 3 | 90 24 05 008 00 90 | nipple set | 1 | 2 |
| 4 | 09 14 10 504 90 | seal | 1 | 2 |
| 5 | 90 29 30 040 00 90 | insert | 1 | 2 |
| 6 | 09 17 11 044 20 90 | distributor | 1 | 2 |
| 7 | 09 27 97 034-47 | rosette | 1 | 30 |
| 8 | 09 31 11 049 90 | pin | 4 | 2 |
| 9 | 09 30 30 147 90 | screw | 2 | 2 |
| 10 | 09 30 30 086 90 | screw | 4 | 2 |
| 11 | 09 30 01 104-47 | casing | 1 | 30 |
| 12 | 09 14 03 504 90 | seal | 1 | 2 |
| 13 | 09 11 94 046-47 | spout | 1 | 30 |